

C2G

 CHIEF

 DA-LITE

LUXUL



vaddio

AMAZING AV EXPERIENCES



2020 SPOTLIGHT PRODUCTS

AMAZING AV EXPERIENCES

Legrand is the global specialist in electrical and digital building infrastructures. Its comprehensive offering of solutions for commercial, industrial and residential markets makes it a benchmark for customers worldwide. In the AV space, Legrand | AV offers an extended portfolio of branded audiovisual products including flat panel mounting solutions, projector mounts, projection screens, switches, routers, cabling and connectivity, equipment racks, PTZ cameras and furniture for Commercial AV markets. Its innovative products are sold under the C2G, Chief, Da-Lite, Luxul, Middle Atlantic, Projecta and Vaddio brand names. All brands work together to provide a breadth of product, strength of longevity, and advantage of superior customer service and support.

C2G

C2G simplifies Audio-Video and PC connectivity for commercial applications. Our solutions are innovatively designed to provide the critical features needed for the space they occupy in corporate, education, healthcare, government and other crucial environments.

CHIEF

Chief has an expansive portfolio of inspired solutions for flat panel displays, projectors, desktop monitors and other AV components. Through deep customer and end-user empathy, Chief continually strives to create amazing technology experiences.

DA-LITE

For over 100 years, Da-Lite has been designing, manufacturing and marketing the most comprehensive line of projection screens in the world. Today, we offer our widest selection ever of proprietary projection screen surfaces and materials in our history.

LUXUL

Luxul is the leading innovator of simple-to-deploy, professional-grade IP networking solutions for use by custom installation professionals. Designed for use in both residential and commercial environments, the Luxul family offers a complete line of solutions that simplify network design and deployment — resulting in a scalable network that is both powerful and easy to install. With Luxul, installers can deliver the ultimate IP network without the complexity associated with traditional networking gear.

MA

Middle Atlantic offers innovative system enclosures, tech-enabled furniture, power products and Wiremold cable management solutions for complete and unmatched AV system support and protection.

vaddio

Vaddio manufactures professional quality PTZ cameras, Pro AV solutions, a full suite of Unified Communication and Collaboration systems. Combining enterprise class performance and industry leading support, Vaddio products enhance any AV experience by elevating the science of communication with The Art of Easy.

legrand® | AV av university

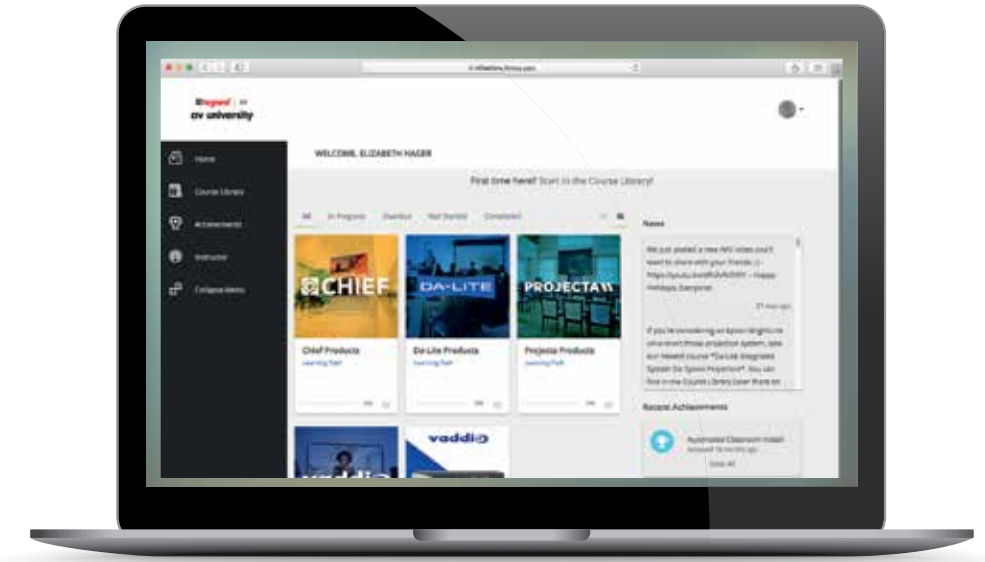

Online Training Courses

AV University is home to Chief, Da-Lite, Middle Atlantic and Vaddio training courses. All courses are free and many offer CTS Renewal Unit credits. Our wide variety of course options include product certifications, installation tips & tricks, how-to-videos, application specifics, general industry knowledge and much more. The program allows you to pick and choose your courses to help you create exceptional AV experiences every day. You can learn on your own time, at your own pace.

TO REGISTER FOR COURSES GO TO: www.legrandav.com/training



AMAZING AV EXPERIENCES

Boardroom

Support dynamic meetings to bring business to the next level.

C2G

29976
HDMI Over IP Decoder – 4K 60Hz
(pairs with the RoboSHOT 20 UHD)

40850
HDMI, USB-C, Mini Display Port, & VGA to HDMI Switch

41368
75ft Active High Speed HDMI Cable – CL2/3

LUXUL

AMS-1816P
AV Series 18-Port/16 PoE+ Gigabit Managed Switch (185W PoE+)

CHIEF

RMAU
Elite Projector Mount
CMS440
Above Tile Suspended Ceiling Kit

XTM1U
Fusion Wall Mount

CSSMP15X10
Component Storage Sliding Mounting Plate

Ma

C5 Series Credenza
Maximum Design Flexibility and Capacity

T5 Series
Conference table with rackmount and small device mounting

Premium+ PDU with RackLink
Intelligent Power Solutions for Remote Management

Premium Series UPS
Reliable backup power for protecting high end and sensitive AV equipment

DA-LITE

Tensioned Advantage
Ceiling Recessed Tensioned Electric Projection Screen

Tensioned Contour
Wall or Ceiling Mounted Tensioned Electric Projection Screen

FullVision
Borderless Fixed Frame Projection Screen

vaddio

RoboSHOT IW
In-Wall Smart Glass OneLINK Bridge Camera System

CeilingMIC
Echo-Canceling Ceiling Microphone

RoboSHOT 20 UHD
PTZ Camera



AMAZING AV EXPERIENCES

Classroom

Create active learning spaces to match modern learning methods.

C2G

27136
50ft Cat6 Snagless Unshielded (UTP) Network Patch Cable – Grey

29510
HDBaseT HDMI + USB Extender

50181
3ft Premium High Speed HDMI Cable with Ethernet – 4K 60Hz

LUXUL

XWS-2510
802.11ac AC1900 Wireless Controller System

CHIEF

LFE1U
Large Capacity Height Adjust Flat Panel Stand

KXC220B
KX Low-Profile Dual Monitor Arm

KITEC
Universal All-in-One Projector Kits

Ma

VWM Series
High Capacity, Most Versatile Wall Mount Cabinet

L5 Series Lectern
Maximum Design Flexibility

L7 Series Lectern
Elegant, ADA Compliant Height Adjustable Lectern

DA-LITE

Parallax Thin
Ambient Light Rejecting Screen

IDEA Screen
Interactive Dry Erase Projection Screen

Integrated Interactive System (AN3)
Conveniently Packaged IDEA Screen System

vaddio

RoboTRAK
Presenter Tracking System

DocCAM
HD In-Ceiling Document Camera

RoboSHOT 30E HDBT
PTZ Camera



AMAZING AV EXPERIENCES

Meeting Room

Break meetings out of the box with AV for the meeting room.

C2G



29329
Wireless AV
for HDMI Devices



29674
1.5ft High Speed HDMI Cable
with Gripping Connectors

LUXUL



XAP-1610

CHIEF



CSMP9X12
Component Storage Panel



Tempo
Flat Panel Floor
Support System

DA-LITE



Parallax Thin
Ambient Light
Rejecting Screen



IDEA Screen
Interactive Dry Erase
Projection Screen



DescenderPro
Compact Ceiling Recessed
Electric Screen

WIREMOLD®



High Power DC Distribution
Design out wall warts with maximum
power for DC devices



OFR – Overfloor Raceway



C3 Series Credenza
Low-Profile AV Credenza



**InteGreat™ Cable
Management Solutions**

vaddio



Easy IP System



ConferenceSHOT AV
Conferencing Bundle



USB 3 AOC Cable
Type C to Type A – Plenum Rated



AMAZING AV EXPERIENCES

Huddle Space

Experience the interactive collaboration that you can create for the huddle space.

C2G



29474
USB-C to HDMI
Audio/Video Adapter



29749
USB-C to Ethernet Adapter
with Power Delivery



56784
10ft High Speed HDMI Cable
with Ethernet Cable - 4K 60Hz

LUXUL



AMS-1208P
AV Series 12-Port/8 PoE+ Gigabit
Managed Switch (130W PoE+)

CHIEF



CSSMP15X10
Component Storage
Sliding Mounting Plate



LSM1U
Fusion Large Static Wall Mount
with FCAV1U Extension Accessory

MA



Hub Collaboration Furniture
All-In-One Huddle Table



UTB Series Universal TechBox™
Low-Profile Height-Adjustable Rack
Ideal for Under Table Mounting



Compact Select Series with RackLink™
Remote power monitoring and control
for displays and small systems

DA-LITE



IDEA Screen
Interactive Dry Erase
Projection Screen



**Integrated Interactive
System (AN3)**
Conveniently Packaged
IDEA Screen System

vaddio



ConferenceSHOT FX
Fixed Camera



TableMIC
Microphone

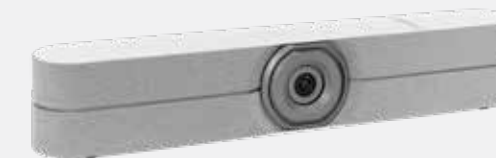

HuddleSHOT
All-in-One
Conferencing Camera
with Integrated Audio



C2G



Connectivity

FOR ALL YOUR AV NEEDS

C2G simplifies audio/video and IT connectivity for commercial applications. Our solutions are innovatively designed to provide the critical features needed for the space they occupy in corporate, education, healthcare, government and other crucial environments.

- Conference & Huddle Room Connectivity
- Digital Adapters, Converters & Extenders
- USB-C Docks
- Networking & PoE ready copper solutions
- OEM & custom solution capabilities

C2G



HDMI Connectivity

- 4K from 1 to 50 ft Passive and 1 to 300 ft Active
- PVC, in-wall, and plenum rated cable jacket options
- HDMI over IP streaming and HDBaseT extension solutions
- Splitters and switches for multi-input or multi-output applications



Category 5E, 6, & 6a Cabling

- 14 color options with connectors designed for easy removal from deep or shallow ports
- Slim, TAA, US Made, Plenum and Shielded & Certified HDBaseT options
- Meets the ANSI/TIA-568-C.2 standard for Patch Cord Performance



USB-C Connectivity

- Docking stations for workstations and on-the-go
- Cables and adapters for USB 3.1 and Thunderbolt 3 applications
- A/V adapters and adapter cables for connecting a USB-C device to a display
- Data adapters for connecting a USB-C device to existing technology



USB Connectivity

- USB 2.0 and USB 3.0 cables and adapters for data transfer and sync
- Passive cables in lengths up to 5m and active extension cables up to 75ft
- USB over Category cable solutions for extension up to 328ft
- Power adapter options for AC or DC to USB for mobile device charging



DisplayPort & Mini DisplayPort

- Passive cables in lengths up to 35ft
- Active DisplayPort cables in length up to 100ft
- MST hubs for multi-monitor application from a single port
- Adapters for connecting from DisplayPort or Mini DisplayPort to an HDMI, DVI, or VGA display



AC Power Cabling

- Universal (C13) power cables for PCs and monitors in lengths up to 25ft
- Power extension cables in lengths up to 25ft
- Splitter cables for powering multiple devices from a single outlet



Premium High Speed HDMI Cables – 4K 60Hz

Premium High Speed HDMI® Cables are designed for a high performance (18Gbps) point-to-point HDMI connection. Independent testing certifies that these cables meet Premium HDMI standards. These cables support all HDMI 2.0 features, including video resolutions up to 4K (4096 x 2160 at 60Hz, 4:4:4). Available in lengths from 3ft to 20ft.

PREMIUM HIGH SPEED HDMI CABLE WITH ETHERNET – 4K 60HZ:

- 50181 – 3FT
- 50182 – 6FT
- 50183 – 8FT
- 50184 – 10FT
- 50185 – 12FT
- 50186 – 15FT
- 50187 – 18FT
- 50188 – 20FT



High Speed HDMI Cables – 4K 60Hz with Gripping Connectors

High Speed HDMI Cables with Gripping Connectors are perfect for digital signage, video wall, or in-rack connections. The gripping connectors reduce the chance of an accidental disconnect by providing three times greater port retention than a standard HDMI connector. These cables support all HDMI 2.0 features, including video resolutions up to 4K (4096 x 2160 at 60Hz, 4:4:4). Available in lengths from 1.5ft to 15ft.

HIGH SPEED HDMI CABLE WITH GRIPPING CONNECTORS – 4K 60HZ:

- 29674 – 1.5FT
- 29675 – 3FT
- 29676 – 5FT
- 29677 – 6FT
- 29678 – 10FT
- 29679 – 12FT
- 29680 – 15FT



High Speed HDMI Active Optical Cables (AOC) – 4K 60Hz

High Speed HDMI Active Optical Cables (AOC) extend HDMI signals over optical cable at resolutions up to 4K 60Hz. The gripping connectors reduce the chance of an accidental disconnect by providing three times greater port retention than a standard HDMI connector. The Plenum (CMP) rated jacket make these cables perfect for installation in a drop ceiling or raised floor. Available in lengths from 15ft to 300ft.

HIGH SPEED HDMI ACTIVE OPTICAL CABLE (AOC) – 4K 60HZ – PLENUM RATED:

- | | |
|---------------|---------------|
| 41450 – 15FT | 41456 – 125FT |
| 41451 – 25FT | 41457 – 150FT |
| 41452 – 35FT | 41458 – 200FT |
| 41453 – 50FT | 41459 – 250FT |
| 41454 – 75FT | 41460 – 300FT |
| 41455 – 100FT | |



HDMI Splitters & Switches – 4K 60Hz

HDMI Splitters and Switches are designed for huddle spaces, small conference rooms, or small-scale digital signage systems. Available as a 3 or 5 port switch for multi-input applications, and a 2 or 4 port splitter for multi-output applications. These switches and splitters support all HDMI 2.0 features including resolutions up to 4K at 60Hz.

- 41394 – 2-PORT HDMI SPLITTER – 4K 60HZ
- 41395 – 4-PORT HDMI SPLITTER – 4K 60HZ
- 41396 – 3-PORT HDMI SWITCH – 4K 60HZ
- 41397 – 5-PORT HDMI SWITCH – 4K 60HZ



HDMI over IP – 4K

HDMI over IP broadcasts 4K HDMI audio/video and control signals over a network to support video walls, digital signage systems, and point to point extensions—all with multiview & matrix support and powered by Power over Ethernet (PoE). H.264/H.265 technology allows this solution to broadcast at a 4K video resolution while only requiring 15Mbps of network bandwidth.

- 29975 – HDMI OVER IP ENCODER 4K 30HZ
- 29976 – HDMI OVER IP DECODER 4K 60HZ
- 29977 – NETWORK CONTROLLER FOR HDMI OVER IP



DisplayPort Cables – 8K

DisplayPort™ Cables are designed for connecting a computer to a monitor in a desktop application. These cables support a High Bit Rate (HBR) digital audio/video connection at up to a 8K video resolution. The DisplayPort connectors feature latches that reduce the chance of an accidental disconnect. Available in lengths from 1ft to 35ft.

- DISPLAYPORT CABLE WITH LATCHES – 8K UHD
- 54423 – 1FT
- 54400 – 3FT
- 54401 – 6FT
- 54402 – 10FT
- 54403 – 15FT
- 54424 – 20FT
- 54404 – 25FT
- 54425 – 30FT
- 54405 – 35FT



DisplayPort MST Hubs – 4K

DisplayPort MST Hubs are designed for dual monitor connections for a laptop or tablet in a desktop application. These MST Hubs support mirroring, extending, or expanding desktop images at up to a 4K video resolution. Connections for either DisplayPort or Mini DisplayPort laptops and tablets and monitor options include Dual HDMI and Dual DisplayPort.

- 54290 – MINI DISPLAYPORT 1.2 TO DUAL DISPLAYPORT MST HUB – 4K
- 54291 – DISPLAYPORT 1.2 TO DUAL DISPLAYPORT MST HUB – 4K
- 54292 – MINI DISPLAYPORT 1.2 TO DUAL HDMI MST HUB – 4K
- 54293 – DISPLAYPORT 1.2 TO DUAL HDMI MST HUB – 4K



USB-C to HDMI Adapter Cables – 4K 60Hz

USB-C to HDMI Adapter Cables connect a USB-C laptop or tablet or a display in a desktop application. These adapter cables are plug and play and do not require drivers or software. Available in lengths from 3ft to 15 ft. In addition to the USB-C to HDMI Adapter Cables, a dongle form factor, along with USB-C to DisplayPort and USB-C to VGA options are available.

- USB-C TO HDMI AUDIO/VIDEO ADAPTER CABLE – 4K 60HZ:
- 26888 – 3FT
- 26889 – 6FT
- 26891 – 9FT
- 26890 – 15FT



Thunderbolt 3 cables

Thunderbolt™ 3 Cables deliver video, data, and power between Thunderbolt 3 devices in a desktop application. An audio/video signal to support two monitors at a video resolution up to 4K at 60Hz. Data transfer speeds over the 1.5ft cable are supported at up to 40Gbps while the longer length cables support up to 20Gbps. Power delivery of up to 100W is supported for device charging or operation. Available in lengths from 1.5ft to 6ft.

- 28840 – 1.5FT THUNDERBOLT 3 CABLE (40GBPS)
- 28841 – 3FT THUNDERBOLT 3 CABLE (20GBPS)
- 28842 – 6FT THUNDERBOLT 3 CABLE (20GBPS)



USB-C Docking Station

USB-C Docking Stations are an ideal solution for creating a complete desktop solution through a single connection. Docking station connectivity options include audio/video connections through HDMI, DisplayPort or VGA, wired network connectivity, and data transfer through USB-A or USB-C ports.

- 28845 – USB-C DOCKING STATION WITH 4K HDMI, ETHERNET, USB & POWER DELIVERY
- 54439 – USB-C MST DOCKING STATION WITH HDMI, DISPLAYPORT, VGA, & POWER DELIVERY – 4K 30HZ



USB 2.0 over Cat6 Extenders

USB 2.0 over Cat6 Extenders are a perfect solution for connecting High Speed USB devices (up to 480mbps data transfer) at long lengths in a classroom, conference room, or huddle space. These extenders support up to 150ft extensions, far exceeding the 16ft cable length limitation of USB. Plug and play installation is quick and easy with no software or drivers required. Available in a box to box and wall plate to box configuration.

- 54284 – 1-PORT USB 2.0 OVER CAT6 EXTENDER (BOX TO BOX)
- 54289 – 1-PORT USB 2.0 OVER CAT6 EXTENDER (WALL PLATE TO BOX)



Cat6a Snagless UTP Patch Cables

The C2G Cat6a Snagless UTP Patch Cables meet all Cat6a TIA/EIA standards, and are ideal for network, AV over IP, or AV extension applications. The molded, snagless boot prevents unwanted cable snags during installation and provide extra strain relief. These patch cables are available in lengths from 6in to 150ft and in 11 different colors.

- 50885 – 50FT CAT6A SNAGLESS UNSHIELDED (UTP) PATCH CABLE – GRAY



Tempo Flat Panel Floor Support System

The Tempo™ Flat Panel Floor Support System uses the floor instead of the wall to support displays, while maintaining a low profile. This eliminates the need for wall inspection and remediation, saving time and cost across large rollouts. The two uprights support the mount and can be moved to adjust to outlets or other obstructions on site, while keeping the flat panel placement precisely where the system designer wants it. Cables can be run down through the uprights or behind the middle cover. The lower section houses an included component storage panel, and the lower cover can be customized to match surrounding finishes for superior aesthetics.

AVSFSS – TEMPO FLAT PANEL FLOOR SUPPORT SYSTEM

Chief mount sold separately. Compatible with:
LTM1U, MTM1U, LSM1U, MSM1U, RXF2, RLF2, RMF2
 Weight Capacity: 200 lbs (90 kg)
 Center of Display Height Range: 51.6 – 75.1" (131-191 cm)



Impact Series Floor Mounted Kiosk

Impact™ Floor Mounted Kiosk brings a new level of flexibility to the digital signage enclosure market, providing an aesthetic solution for enclosing displays in open areas. Designed with no exposed fasteners while maintaining full access and serviceability. Our exclusive design keeps the display mounted to the frame when opened. Keyed locking security keeps displays safe, and a universal AV storage plate holds supporting equipment. Single and back-to-back options accommodate displays up to 3.5" (89 mm) thick. Accessories include protective glass, and thermal management options.

Mounting Patterns: 200 x 200, 300 x 300, 400 x 400 mm
 Weight Capacity, 49-55" Displays: 125 lbs (56.7 kg)
 Maximum Screen Thickness: 3.5" (89 mm)
 Finish Options: Black, White

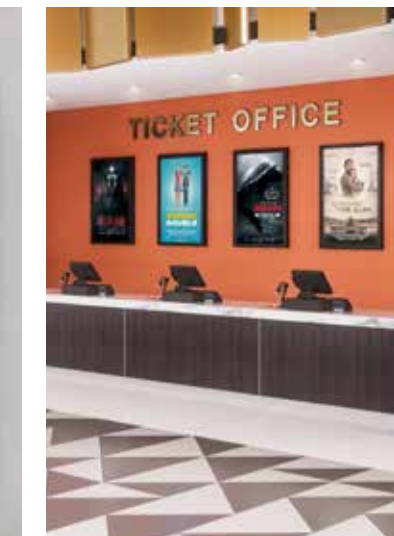

Impact Series Wall Mounted Kiosks

Impact Wall Mounted Kiosk brings a new level of flexibility to the digital signage enclosure market, while maintaining a sleek aesthetic to complement a variety of environments. A depth-adjustable exterior frame keeps the installation under 4" (102 mm) for displays up to 2.75" (70 mm) deep. Reversible hinges help to avoid installation and service obstructions, and our exclusive design keeps the display mounted to the frame when opened, providing unparalleled service and maintenance access. Integrated engagement latches can be secured with tamperproof hardware to protect equipment. Multiple Storage options can be added to mount components in-wall and/or on-wall.

Mounting Patterns: 200 x 200, 300 x 300, 400 x 400, 600 x 400, 600 x 600 mm
 Weight Capacity, 40-48" Displays: 100 lbs (45.4 kg)
 Weight Capacity, 49-55" Displays: 125 lbs (56.7 kg)
 Weight Capacity, 65-75" Displays: 200 lbs (90.7 kg)
 Center of Display Height Range: 51.6 – 75.1"
 Depth Range: 3-5" (76 – 127 mm)
 Finish Options: Black, White



TiLED LED Video Wall Mounting System

Easy to Specify. Easy to Order. Easy to Install.

We've taken the installation benefits you know and love from Chief and adapted them to support LED displays.

The TiLED™ mounting system supports an endless variety of video wall configurations, is easy to specify, easy to order and easy to install. Mix and match any of four mounts from a specific series to form seamless video walls. As a standard solution set, TiLED is in-stock and ready to ship when you need it – no custom lead times.

ABSEN® ACCLAIM™ SERIES: TIL1X2AA, TIL1X3AA, TIL1X4AA

Depth Range with Display: 3.63-4.63" [92-118 mm]

SAMSUNG® IFH SERIES: TIL1X1IF, TIL1X2IF, TIL1X3IF

Depth Range with Display: 3.46-4.46" [88-114 mm]

UNILUMIN® UPANELS™ SERIES: TIL1X2UU, TIL1X3UU, TIL1X4UU

Depth Range with Display: 3.85-4.85" [98-123 mm]

LG LAS FINE PITCH & LEYARD® TVF SERIES: TIL1X2PT, TIL1X3PT, TIL1X4PT

Depth Range with Display: 3.59-4.34" [91-110 mm]

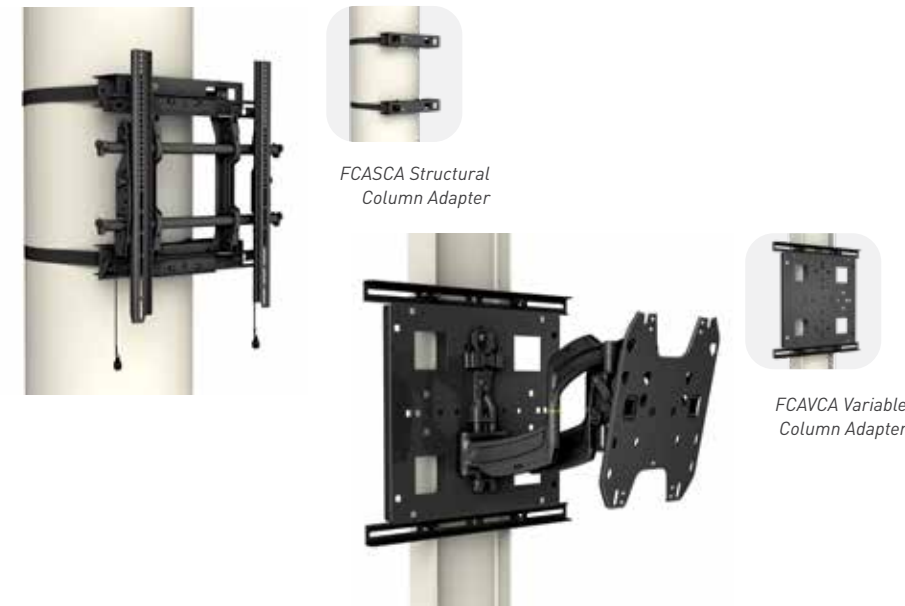

Column Mount Adapters

Chief's new Column Mount Adapters provide an easy solution for mounting to existing structural elements in high traffic areas, such as stadium concourses. The two adapters are compatible with Chief's popular Fusion and Thinstall mounts and can be used on a range of concrete structural columns, I-beams, trusses, box beams and more.

Options available for portrait and landscape orientations, as well as back-to-back applications.

FCASCA STRUCTURAL COLUMN ADAPTER

FCAVCA VARIABLE COLUMN ADAPTER

Weight Capacity: 200 lbs (90.7 kg)

Compatible Mounts: FMSWM, LTM1U, MTM1U, MTMS1U, MTMP1U, TS118SU, TS218SU, TS318SU



Floor-to-Ceiling Cable Mount

Ideal for retail and quick service restaurants, Chief's Floor-to-Ceiling Cable Mount is a sleek solution that maximizes aesthetics while minimizing footprint. The mount supports large displays with a high weight capacity and allows perfect placement with post-installation pitch alignment.

The FCS1U supports both portrait and landscape orientations in a single SKU, with the option to retrofit a second, back-to-back display with the PACFCB accessory. To support reconfigurable installs, the PACFCL accessory provides easy lateral adjustment after installation and the ability to install multiple displays in-line with each other using standard channel strut.

FCS1U FLOOR-TO-CEILING CABLE MOUNT

PACFCB BACK-TO-BACK ACCESSORY

Weight Capacity: 100 lbs (45 kg)

Mounting Pattern: 200 x 200 – 862 x 517 mm

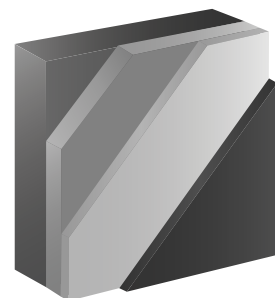

1. Commercial Grade Steel
2. Galvanized Plating
3. Outdoor Primer
4. Outdoor-Rated Paint



Stainless Steel Hardware



Wind Resistant



UV-Resistant Plastics



Warrantied



Quality Assurance

Outdoor Ceiling, Pedestal and Wall Mounts

Outdoor AV installs bring new life to open air spaces, but they also bring new challenges. Extreme temperatures, moisture and UV exposure can lead to faded color, brittle plastic and rusting metal. To combat these problems, Chief's outdoor wall mounts are designed with multiple levels of protection, including galvanized plating and outdoor rated paint and primer (UL 2442 Part II).

For outdoor ceiling installs, wind adds another level of complexity. Chief's new outdoor ceiling mounts are engineered to stand up to extreme wind loads and avoid catastrophic failure. The included wind deflector provides an additional layer of defense to protect technology investments and guests.

- OLCM1U – OUTDOOR SINGLE CEILING AND PEDESTAL MOUNT, LARGE**
- OXC1U – OUTDOOR SINGLE CEILING AND PEDESTAL MOUNT, XL**
- OLCB1U – OUTDOOR BACK-TO-BACK CEILING AND PEDESTAL MOUNT, LARGE**
- OXC1U – OUTDOOR BACK-TO-BACK CEILING AND PEDESTAL MOUNT, XL**
- OLCM2X1U – OUTDOOR 2X1 CEILING AND PEDESTAL MOUNT**
- OLCB2X1U – OUTDOOR BACK-TO-BACK 2X1 CEILING AND PEDESTAL MOUNT**
- ODMLA25 – OUTDOOR SWING ARM MOUNT**
- ODMLT – OUTDOOR TILT MOUNT***
- PSM02085 & PSM02086 – OUTDOOR FIXED MOUNT FOR SAMSUNG OHF DISPLAYS**

**Combine with FHB05085 or FHB05086 for Samsung OHF Outdoor Displays*



XFD1U – Electric Floor Support



XSD1U – Electric Wall Mount



XPD1U – Electric Cart

Electric Height Adjustable Mounts

Chief's line of height adjustable display mounts is expanding to include electric solutions. The new cart, floor-support and wall mounts have higher weight capacities to support larger interactive displays, and also give an option to users who may prefer an electric solution over non-motorized.

Keeping safety top of mind, the electric solutions feature anti-collision technology, which immediately halts, then reverses motion upon encountering an obstruction to avoid pinching fingers, or damaging the display.

- XPD1U – ELECTRIC CART**
- XFD1U – ELECTRIC FLOOR SUPPORT MOUNT**
- XSD1U – ELECTRIC WALL MOUNT**

Vertical Lift: 26" (660 mm)
 Weight Capacity: 310 lbs (140.6 kg)
 Mounting Pattern Range: 200 x 200 – 860 x 510 mm
 Leveling Adjustment: up to 1.5" (38 mm)



VCT XL Projector Mount



CMA348 Large Venue Vibration Isolating Coupler



PG4A XXL Projector Guard

Large Venue Projector Mounts and Accessories

New projector mounts and accessories better align, protect and enhance large venue projection installations. Designed to install quickly while maintaining a sleek aesthetic.

VCT – XL PROJECTOR MOUNT

Weight Capacity: 150 lbs (68 kg)
 Micro Roll / Pitch / Yaw: +/-5°, +/-20°, +/-10°
 Macro Yaw: 360°

CMA348 – LARGE VENUE VIBRATION ISOLATING COUPLER

Weight Capacity: 35 – 100 lbs (15.87 – 45.4 kg)*
 Overall Dimensions: 6 x 23 x 23" (152 x 584 x 584 mm)
 Compatibility: Chief CMS Columns (1.5" NPT)

**Capacity must include all components below the coupler: column, projector mount, projector, etc.*

PG4A – XXL PROJECTOR GUARD

Overall Dimensions: 16 x 26 x 27" (406 x 660 x 686 mm)
 Telescoping Depth Range: 22-27" (559 – 686 mm)



PARALLAX PURE



Parallax Pure Screen Surface

Parallax® Pure is a True Optical ALR solution that features an optical lens system to reject light. Multiple surface layers absorb light while one special layer is shaped like a microscopic saw-tooth to block light from above, preserving high contrast images in brightly lit environments.

USE PARALLAX PURE WHEN:

- The most ambient light rejection is needed in an installation
- Sizes are up to 120" diagonal in 16:9
- Image quality and resolution are critical
- A variety of gain types may be needed to accommodate projector models or lenses

4K-READY SCREEN SURFACES



PARALLAX PURE 0.8*
Half Angle: 85°
Gain: 0.8



PARALLAX PURE 2.3^
Half Angle: 23°
Gain: 2.3



PARALLAX PURE UST 0.45*
Half Angle: 80°
Gain: 0.45



PARALLAX STRATOS



Parallax Stratos Screen Surface

Parallax Stratos is a Contrast Based ALR solution. The gray color and other proprietary design elements in the surface combine to absorb ambient light rather than reflect it. Engineered as a high value surface for large scale installations, Parallax Stratos maintains and enhances image contrast for viewers.

USE PARALLAX STRATOS WHEN:

- High ambient light rejection is needed in an installation
- Sizes are larger than 120" diagonal in 16:9
- Color and contrast need to be enhanced in the projected image
- A single surface solution with a variety of product types can solve the basic ambient light rejection needs of the project

4K-READY SCREEN SURFACES



PARALLAX STRATOS 1.0^
Half Angle: 30°
Gain: 1.0

HD PROGRESSIVE



HD Progressive Screen Surface

HD Progressive projection surfaces are designed to perfectly reflect and preserve the image being projected for Pro AV installations. This screen surface technology is designed for high-resolution and laser projection, creating the most crisp, clear image in the industry. Ensure a future proof installation with 16K-ready surfaces.

16K-READY SCREEN SURFACES



HD PROGRESSIVE 0.9*
Half Angle: 85°
Gain: 0.9



HD PROGRESSIVE 0.6*
Half Angle: 85°
Gain: 0.6



HD PROGRESSIVE 1.1*
Half Angle: 85°
Gain: 1.1



HD PROGRESSIVE 1.1 CONTRAST*
Half Angle: 60°
Gain: 1.1



HD PROGRESSIVE 1.3^
Half Angle: 75°
Gain: 1.3

* Recommended for laser projection
^ Suitable for laser projection



Fast-Fold Deluxe

The enhanced Fast-Fold® Deluxe Screen System accommodates all skill levels with intuitive set-up and tear-down for rental and staging applications. Its efficient, portable design features a new leg-to-frame locking mechanism with no parts to lose. Now available with HD Rental – a foldable and optically enhanced screen surface for high definition AV experiences, featuring RF (radio frequency) welded binding for improved aesthetics and durability.

16K-READY SCREEN SURFACES

- HD RENTAL***
Half Angle: 85°
Gain: 1.0
- DUAL VISION***
Half Angle: 65°
Gain: 0.9

STANDARD RESOLUTION SCREEN SURFACE

- DA-TEX®**
Half Angle: 30°
Gain: 1.3

Wireline Advantage

By using thin steel cables up to 29ft instead of black drop, the Wireline™ Advantage® almost invisibly suspends content at just the right viewing height, leaving the architecture of the room exposed for stunning results. Adding to the aesthetics, the Wireline comes with ceiling trim already in place. Available sizes include 133" to 226" diagonals.

16K-READY SCREEN SURFACES

- HD PROGRESSIVE 0.9***
Half Angle: 85°
Gain: 0.9
- HD PROGRESSIVE 1.1***
Half Angle: 85°
Gain: 1.1
- HD PROGRESSIVE 1.3^**
Half Angle: 75°
Gain: 1.3
- HD PROGRESSIVE 0.6***
Half Angle: 85°
Gain: 0.6
- HD PROGRESSIVE 1.1 CONTRAST***
Half Angle: 60°
Gain: 1.1
- DUAL VISION***
Half Angle: 65°
Gain: 0.9

4K-READY SCREEN SURFACE

- 80% ALR PARALLAX STRATOS 1.0^**
Half Angle: 30°
Gain: 1.0

FullVision

A borderless screen with a modern aesthetic that blends into its environment when not in use, FullVision is a fixed frame projection screen that enables the entire surface to be used for projection. Modern and low-profile, FullVision is 16K-ready and future proof with HD Progressive surface options. Aesthetic forward and designed for rooms that require the AV blend into the environment when not in use and deliver the very best in projection when the projector turns on.

16K-READY SCREEN SURFACES

- HD PROGRESSIVE 0.9***
Half Angle: 85°
Gain: 0.9
- HD PROGRESSIVE 1.1***
Half Angle: 85°
Gain: 1.1
- HD PROGRESSIVE 1.3^**
Half Angle: 75°
Gain: 1.3
- HD PROGRESSIVE 0.6***
Half Angle: 85°
Gain: 0.6
- HD PROGRESSIVE 1.1 CONTRAST***
Half Angle: 60°
Gain: 1.1

DescenderPro

DescenderPro is the first Da-Lite ceiling recessed screen to be stocked and available for immediate shipment. Its compact housing is up to a 1/3 smaller than similar electric screens for easy installation in spaces with structural limitations. Available in standard sizes and up to 164" diagonal. Internal junction box, silent motor and low-voltage control (LVC) are standard.

16K-READY SCREEN SURFACES

- HD PROGRESSIVE 0.9***
Half Angle: 85°
Gain: 0.9
- HD PROGRESSIVE 1.1***
Half Angle: 85°
Gain: 1.1

* Recommended for laser projection
^ Suitable for laser projection



LUXUL

Network Switches

FOR THE PRO AV INTEGRATOR

Luxul switches are designed to handle anything from a small conference room to the most demanding AV over IP installations. With a wide variety of switches available, complete with SFP/SFP+ modules for expansion, you're sure to find a switch that meets the needs of your application.

Luxul PoE AV Switches offer these benefits:

- AV over IP ready – for easy integration with leading AV over IP systems
- Ideal AV distribution platform for retail, meeting rooms, corporations and campuses
- Generous PoE+ power budgets – 130W to 640W
- Silent operation
- Ports on the back for a clean rack installation
- Self-Healing Capabilities – PoE auto-recovery and power scheduling
- Three year warranty

LUXUL



AV Series 18-Port Gigabit PoE+ L2/L3 Managed Switch

The AMS-1816P is an 18-port Gigabit switch that easily functions on its own or provides cost effective expandability via its two Gigabit SFP uplink ports to other Luxul switches in your AV rack. The 16 PoE+ ports provide a robust 185W power budget and simple power management to automation touch panels, security cameras, and other PoE powered devices. The compact rack-mountable design, selectable green/blue front facing LEDs, and variable speed fans ensure aesthetic and quiet operation. The AMS-1816P provides simple installation with powerfully intuitive management, including L2/L3 switching, 802.1Q VLAN support with trunking, and QoS prioritization support.

- PoE self-healing with auto-recovery and power scheduling
- 16 Gigabit 802.3af/at PoE+ ports (185W power budget)
- 2 Gigabit SFP ports
- Full layer 2/3 support

AMS-1816P MANAGED AV POE+ SWITCH



12 Port / 8 PoE+ Front-Facing Rackmount Switch

The XMS-1208P is a 12 port/8 PoE+ front-facing rackmount switch that provides silent fan-less operation, 24Gbps switching capacity, Layer 3 static routing, 802.1Q VLAN support with trunking, and QoS prioritization--perfect for security and small business installations. The 8 Gigabit 802.3af/at PoE+ ports and 130W budget provide robust power and simple management for security cameras, VoIP phones, and other PoE powered devices. The two Gigabit Ethernet or two SFP ports can be used for devices or uplinking to other switches.

- PoE self-healing with auto-recovery and power scheduling
- 8 Gigabit 802.3af/at PoE+ ports
- 130W power budget
- 2 Gigabit ethernet uplink ports
- 2 Gigabit SFP uplink ports
- 24 Gbps switching capacity

XMS-1208P FANLESS MANAGED POE+ SWITCH





AV Series 12-Port / 8 PoE+ Gigabit Managed Switch

The Luxul AV-Series 12-Port/8 PoE+ Gigabit Managed Switch (AMS-1208P) features rear panel ports and front facing LEDs (user selectable blue/green colors) for clean integration with AV rack systems. It is an excellent choice for expanding your network when using PoE-enabled devices such as VoIP, IP cameras and Wireless Access Points.

- PoE self-healing with auto-recovery and power scheduling
- 10, Gigabit RJ45 ports
- 2, Gigabit SFP ports
- 130W power budget
- 24Gbps switching capacity

AMS-1208P

Includes 8 PoE+ ports, total power budget of 130 Watts
Features 2 Gigabit RJ-45 & 2 Gigabit SFP ports for easy network expansion



AV Series 26 Port/24 PoE+ Stackable L2/L3 Managed Switch

The AMS-4424P features rear panel ports and front facing LEDs (user selectable blue/green colors) for clean integration with AV rack systems. With 24 Gigabit RJ-45 PoE+ ports and two 10 Gigabit SFP+ stacking ports, it provides superior network performance and seamless scalability/management of up to 16 switches (384 ports). Includes 24 PoE+ ports, allowing the use of standard Ethernet cable to deliver both power and high speed data to 802.3af/at-compliant devices, with a total power budget of 250 Watts.

- PoE self-healing with auto-recovery and power scheduling
- 24 Gigabit 802.3af/at PoE+ Ports (250W power budget)
- Two 10 Gigabit SFP+ ports 88 Gbps switching capacity
- Full layer 2/3 support

AMS-4424P

Includes 24 PoE+ ports, total power budget of 250 Watts



Wireless Controller

The XWC-2000 Wireless Controller uses Luxul's exclusive Roam Assist™ technology to ensure active roaming of mobile client devices within wireless networks that utilize more than one wireless access point (AP), while providing simple, centralized deployment of up to 32 Luxul APs through an easy-to-use setup wizard.

- Active client roam between access points with Luxul Roam Assist
- Simple central control and configuration of Luxul Aps
- Secure guest networking
- Supports up to 32 wireless Aps

XWC-2000 WIRELESS CONTROLLER

Compatible with the following Luxul APs:

XAP-1510, XAP-810, XAP-1240, XWO-BAP1

Installers can mix and match APs to maximize the performance and budget of each project
Available standalone or in kits, complete with APs and PoE hardware



ProWatch Legrand Remote Management Tool

Cloud management solutions. Your client's networks host more connected devices than ever before, and their expectations for them all to work seamlessly are higher than ever. With Luxul ProWatch, monitor and manage every device on the network to proactively respond to issues while avoiding truck rolls for simple system management tasks.

With the following features, enjoy peace of mind, knowing your clients' systems will be accessible at any time from anywhere:

- Receive notifications when devices fall offline
- Perform firmware updates on select Luxul routers and access points
- Customizable alerts
- Site-level status indicators for offline devices and firmware updates
- Access sites in map or list views
- Configure devices remotely via web user interfaces
- Remotely power cycle PDUs and PoE switches



L7 Series Lecterns

Joining the L2 and L5 Series for a full suite of lecterns to adorn the campus is the L7 Series Lectern—the most elegant solution in height adjustability. Transforming today’s learning spaces in its ability to unite the needs of AV system integrators and educators, this lectern flaunts dramatic curves to highlight the generous workspace while delivering ADA compliance and the equipment storage and connectivity expected from Middle Atlantic.

BUILT FOR INTEGRATORS

- Welded steel frame with modular rackmount and storage options
- Additional small device storage available below the worksurface
- Integrated power, cable and thermal management for ultimate system reliability
- Popular AVIP plates for higher education application

DESIGNED FOR EDUCATORS

- 61" by 31" workspace to accommodate personal devices
- Wireless charging pad to keep Qi cellular devices charged during class
- Ample USB and AC outlets as well as storage for markers & microphones



C3 Series Credenza

The new 10" deep, ADA Compliant C3 Credenza series displays modern contrasted finishes, versatile storage options and at 10" deep a minimal footprint, perfect underneath displays, in high traffic areas, hallways, and meeting spaces. Middle Atlantic’s unmatched Frame to Furniture design process allows for maximum uptime and reliability that gets your AV gear installed and ready to use quickly. With the hallmark Middle Atlantic systems approach, each credenza comes with power and thermal management built in, making it truly an all in one piece of furniture.

- 1, 2 & 4 bay models in 24" or 31" heights
- Thermolaminate or high pressure laminate finishes
- Designed to accommodate both rackmount and small device mounting

WIREMOLD®



Wiremold Outdoor Ground Box



Wiremold Outdoor Charging Station

WIREMOLD® Outdoor AV & Power

With real estate at a premium, Wiremold opened up a new world of possibilities, making the most out of outdoor spaces. Delivering AV, power, and data connectivity safely and conveniently, the Outdoor Charging Station and Ground Box boast rugged, weather-safe designs in premium, durable finishes to enhance the way guests and employees think of and interact with exterior spaces.

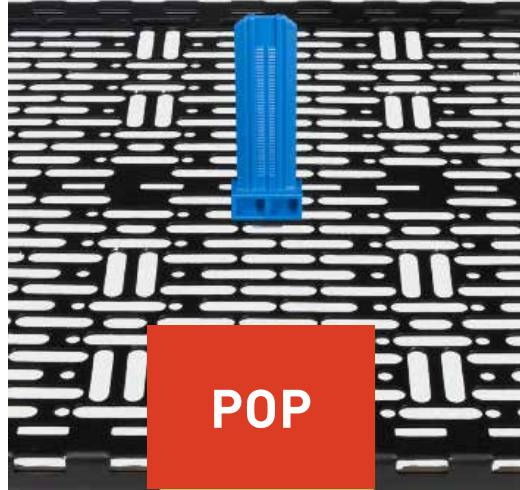

POP



ZIP

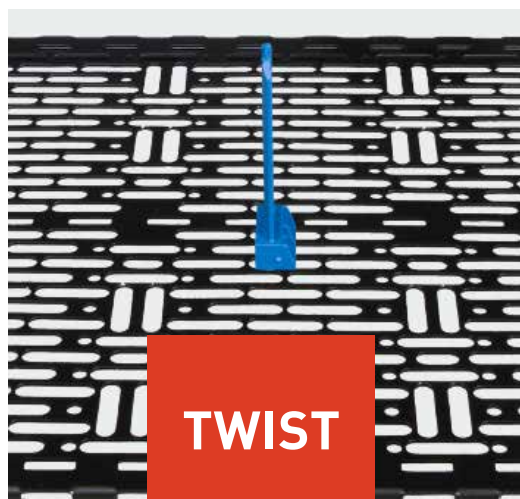

TWIST



NEW! Forward for Today's Systems at Tomorrow's Speed

Enabling **5x faster installation** of everyday rack builds so you can focus on what matters – delivering the ultimate AV experience.

Redefined Rackrail for the fastest installation now included in all BGR series enclosures.

The threaded rail includes a square hole that unlocks the ability for all of our Forward panels, vents and cable management to be clicked in without using ANY rack screws!



ADDITIONAL NEW FORWARD ACCESSORIES INCLUDE:

- **Lighting** – mounts without tools to illuminate workspace efficiently
- **Cable Management and Power Bracket Solutions** – mount without tools to run cables and mount power strips with ease
- **Blank and Vent Panels** – achieve optimal rack design in seconds and with no hardware
- **UPS Base** – comes preinstalled and ready to plug in out of the box
- **Small Device Mounting** – allows mounting of small devices without any hardware, zip ties or bubble gum

BGR-4532-FWD



Premium+ PDU with Racklink

Securely monitor, control and manage your AV systems by unleashing the full potential of RackLink™ with the new Premium+ PDU. Get individual outlet power cycling/logging, advanced system monitoring & control and maximum security with Premium+ PDUs with RackLink.

- Accurate power monitoring & logging down to the outlet level
- Enhanced environmental monitoring capabilities with up-to 32 individual sensors able to be connected to a single unit
- RackLink has comprehensive control options for proactive system management and restoration if equipment issues occur
- Superior protection (under/over voltage, filtering) on all models and industry leading surge detection & protection with our patented Series Protection non sacrificial surge suppression on –SP models.



RoboSHOT 40 UHD Broadcast-Quality PTZ Camera

The production-quality RoboSHOT® 40 UHD PTZ camera provides brilliant 4K video footage for broadcasting or live streaming. With its 1/2.5 Type Exmor R CMOS sensor, RoboSHOT 40 UHD offers more powerful image signal processing (ISP) – resulting in better light-gathering capabilities, incredible contrast and sharp 4K video, even in dim lighting conditions. It delivers 40x zoom, genlock capabilities, silky-smooth pan-tilt-zoom motion and outstanding image quality – all at a surprisingly competitive price.



RoboSHOT 30E NDI Camera

For PTZ video installations that require an NDI® signal, there is no better option than the RoboSHOT 30E NDI camera. This Elite Series camera complies with the most rigorous NDI standards to deliver the lowest latency for live, on-air camera control, switching and streaming. Achieve plug and play simplicity by connecting the camera to the network and opening your NewTek control software.

- 30x zoom
- 1/2.5-type Exmor R CMOS sensor
- 70.2° horizontal field of view
- Simultaneous HDMI and native NDI streaming



AV Bridge Mini HD Audio/Video Encoder

The AV Bridge Mini includes all your favorite features of Vaddio's AV Bridge and AV Bridge Conference, plus significant updates – all in an easy-to-install, half-rack size. With AV Bridge Mini, you can bridge any high-definition HDMI and audio source into applications such as Skype for Business, Zoom and WebEx through its powerful USB 3.0 interface. Creating production-quality live streams has never been easier with the AV Bridge Mini's RTMP capabilities.

- HDMI input accepts 4k (2160p/30) signals and encodes and scales appropriately
- Outputs simultaneous USB 3.0 and IP streaming with up to 1080p quality
- Integrates with external DSPs by providing two balanced audio line inputs and output
- PoE powered – easily extends power and connectivity



vaddio



HuddleSHOT

The HuddleSHOT® All-in-One Conferencing Camera with integrated audio is Vaddio's newest solution optimized for huddle spaces. This USB conferencing camera offers great performance, modern aesthetics and built-in IP management. HuddleSHOT provides high definition 1080p/60 resolution for a superior, professional image – and its ultra-wide 125° horizontal FOV gets everyone in the picture.

- Two integrated speakers with wide dynamic range for robust stereo sound, plus two built-in microphones
- Browser-based user interface makes it easy to manage many HuddleSHOT cameras across multiple sites for easy enterprise deployments
- A versatile mount lets you install HuddleSHOT on a table, wall or cart
- Available in black or gray
- Extend microphone pickup for larger huddle rooms with a Vaddio TableMIC

vaddio



TableMIC Microphones

TableMIC microphones connect to Vaddio products with EasyMIC ports to deliver professional-quality audio into your PC system for superior conferencing experiences. Engineered to reduce distracting noises that arise in a conference room, the TableMIC's solid metal base construction, acoustical fabric wrap, and padded rubber feet diminish table vibration noise that other table microphones experience.



CeilingMIC Microphones

CeilingMIC microphones complement most interiors with its sleek design featuring smooth lines and quality acoustical fabric wrap. These overhead microphones deliver the performance of three microphone elements built into a single pendant hanging enclosure.



NEW! AV Bridge 2x1 Presentation Switcher

Vaddio's AV Bridge 2x1 Presentation Switcher is ideal for videoconferencing and lecture capture applications where two cameras are being used.

AV Bridge 2x1 supports two HDMI camera inputs with simultaneous USB 3.0, IP streaming and HDMI outputs. The 12x12 fully mixable audio matrix has mic line inputs, balanced line outputs, HDMI, IP and USB audio, plus 4x4 Dante I/O. Video mixing features configurable PIP and static graphics, which can be orchestrated using triggers, serial or web-based controls.

The PoE+ powered AV Bridge 2x1 bridges HDMI and audio sources into applications such as Zoom through its USB 3.0 interface, while its RTMP capabilities allow streaming on platforms such as Panopto. Its half rack size can be installed easily under a table, providing simple access for BYOD conferencing.



RoboSHOT Elite Series Professional PTZ Cameras

The RoboSHOT Elite Series is Vaddio's next generation of professional cameras. Designed with an 1/2.5 Type Exmor R CMOS sensor, RoboSHOT Elite cameras deliver striking, high-definition video image quality, plus more powerful image signal processing (ISP) – resulting in better light-gathering capabilities, incredible contrast and sharp 1080p/60 video, even in dim areas. Its advanced IntelliZoom™ Image Processing Technology (select models) lets you zoom greater distances without compromising image resolution.

- PoE+ powered
- 70.2° FOV, 8.5 MP, 12x & 30x zoom
- RTSP and RTMP streaming (RTMP on select models)
- Tri-Synchronous Motion technology for ultra-smooth, natural camera motion

Available in six models:
HDBT, HDMI, USB, SDI, CAT5 (QUICK-CONNECT) AND NDI
 Also available as bundles with OneLINK extension systems



New! Vaddio Deployment Tool

Simplify installations by viewing all your compatible Vaddio products across a deployment on one screen with the simple click of a button. The Vaddio Deployment Tool enables you to select devices from the network, choose an action like reboot the device, unmute the audio, or conduct mass firmware updates on hundreds of devices all at once, which saves you a lot of time.

Best of all, it's free. No licenses, no invoices, no maintenance fees. The Vaddio Deployment tool is for our valued integration partners and AV managers who rely on Vaddio products to keep their AV installations running smoothly.

DOWNLOAD AT: <https://info.legrandav.com/VaddioDeploymentTool>



NEW! EasyIP Ecosystem

The EasyIP Ecosystem is an AV-over-IP conferencing system that is easy to use, easy to install and provides industry-leading video quality. With EasyIP, you can deliver a simple, yet professional quality BYOD (bring your own device) conferencing experience by moving videoconferencing onto a standard 1 Gb Ethernet network.

The system works on an IP-based infrastructure, sending video and control signals over the LAN using IP switching and configuration protocols. By offloading the extension and switching to a PoE switch, total cost of the system is reduced, providing a simpler, more affordable alternative to traditional extension systems.

EASYIP ECOSYSTEM IS COMPRISED OF:

- EasyIP USB Decoder
- Up to four EasyIP 10 Cameras, available in black and white
- Luxul AMS-1208p Switch preconfigured for EasyIP
- Two Vaddio TableMIC or CeilingMIC microphones.



AMAZING AV EXPERIENCES | legrandav.com

USA	P 866.977.3901	E av.support@legrand.com
CANADA	P 877.345.4329	E av.support@legrand.com
EMEA	P +31 495 580 840	E av.emea.sales@legrand.com
APAC	P +852 2145 4099	E av.asia.sales@legrand.com

©2019 Legrand AV Inc. 200001 Rev A 2/20 C2G, Chief, Da-Lite, Luxul, Middle Atlantic and Vaddio are a registered trademarks of Legrand AV Inc. All other brand names or marks are used for identification purposes and are trademarks of their respective owners. All patents are protected under existing designations. Other patents pending.

COMMERCIAL BRANDS

C2G | Chief | Da-Lite | Luxul | Middle Atlantic | Projecta | Vaddio